

Made tough... Stays tough...
Stays tough... Made tough...
Made tough... Stays tough...
Stays tough... Made tough...
Made tough... Stays tough...
Stays tough... Made tough...
Made tough... Stays tough...
Made tough. Stays tough...

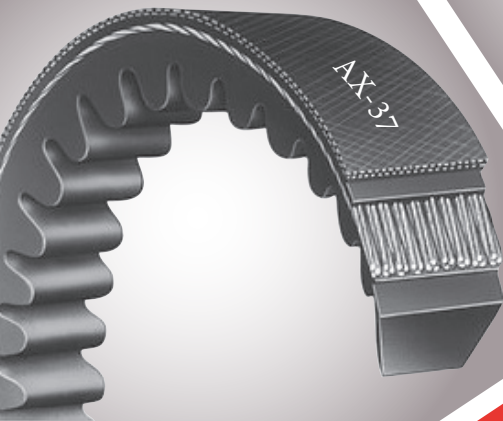

Power Transmission Belts



The ESCOR logo is rendered in a bold, italicized, white font with a thick black outline. The letters are slanted to the right. A registered trademark symbol (®) is positioned at the top right of the logo.

THE BELT WITH STEEL NERVES

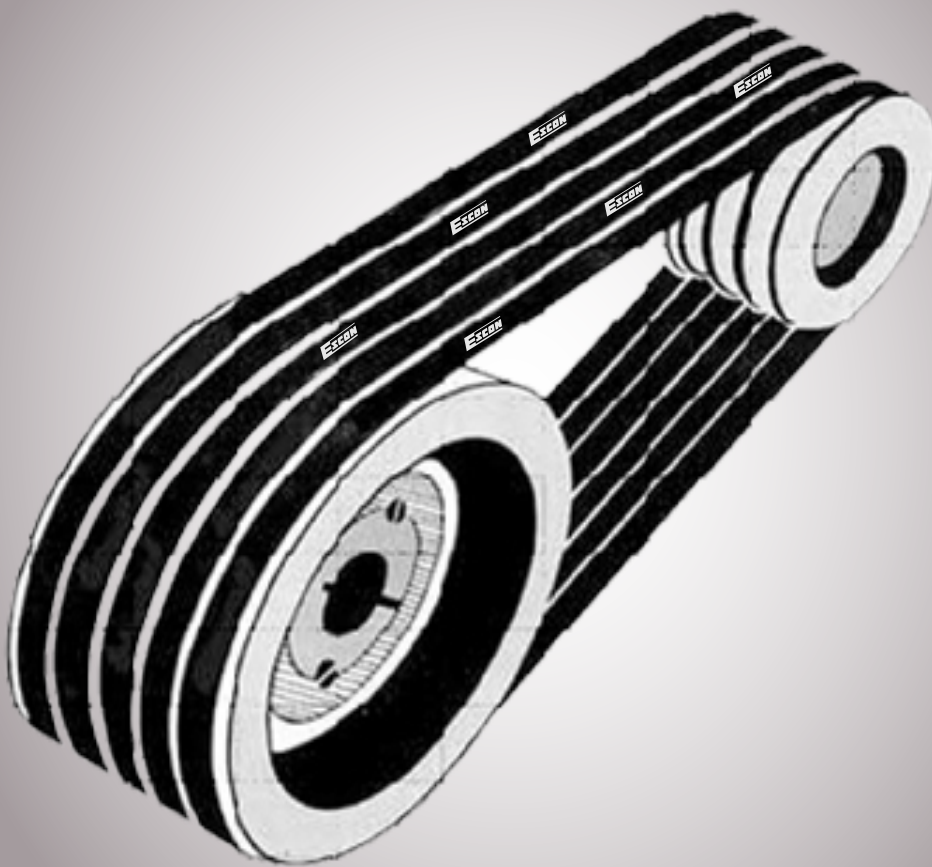

Esccon Classical V - Belt

Esccon Wedge Belt

Esccon Hexagon Belt

Esccon Banded Belt

Esccon Harvester Combine Belt

Esccon Flat Transmission Belt

Esccon FHP Belt

Esccon Raw Edge Cogged Belt

Esccon Poly Belt

Esccon Mud Loader Belt

ABOUT US

Escon Group commenced its Business Activities in early 1950's, and till date is involved in manufacturing and distribution of quality products in Mechanical Power Transmission, Material Handling and Hand- Cutting tools segments.

Escon Superior quality V-Belts are manufactured in India at their two most modern manufacturing units located in Ghaziabad, Uttar Pradesh Since 1992 and District Una, Himachal Pradesh since 2010.

Escon is one among the very few organised manufactures of V-Belts in India and enjoys significant brand equity in the Mechanical Power Transmission Industry.

Escon brings together the required combination of best State of the art Manufacturing Facility, Systematic Approach, High Quality Raw Materials, Technical Expertise and Process control to achieve our mission to "Deliver Customer Satisfaction With Quality Products"

On the customer front Escon understands that in all industries requirement of Mechanical power transmission demands high standards of safety, quality and cost efficiency. Escon V-Belts offer the industry a comprehensive range meeting today's stringent requirements.

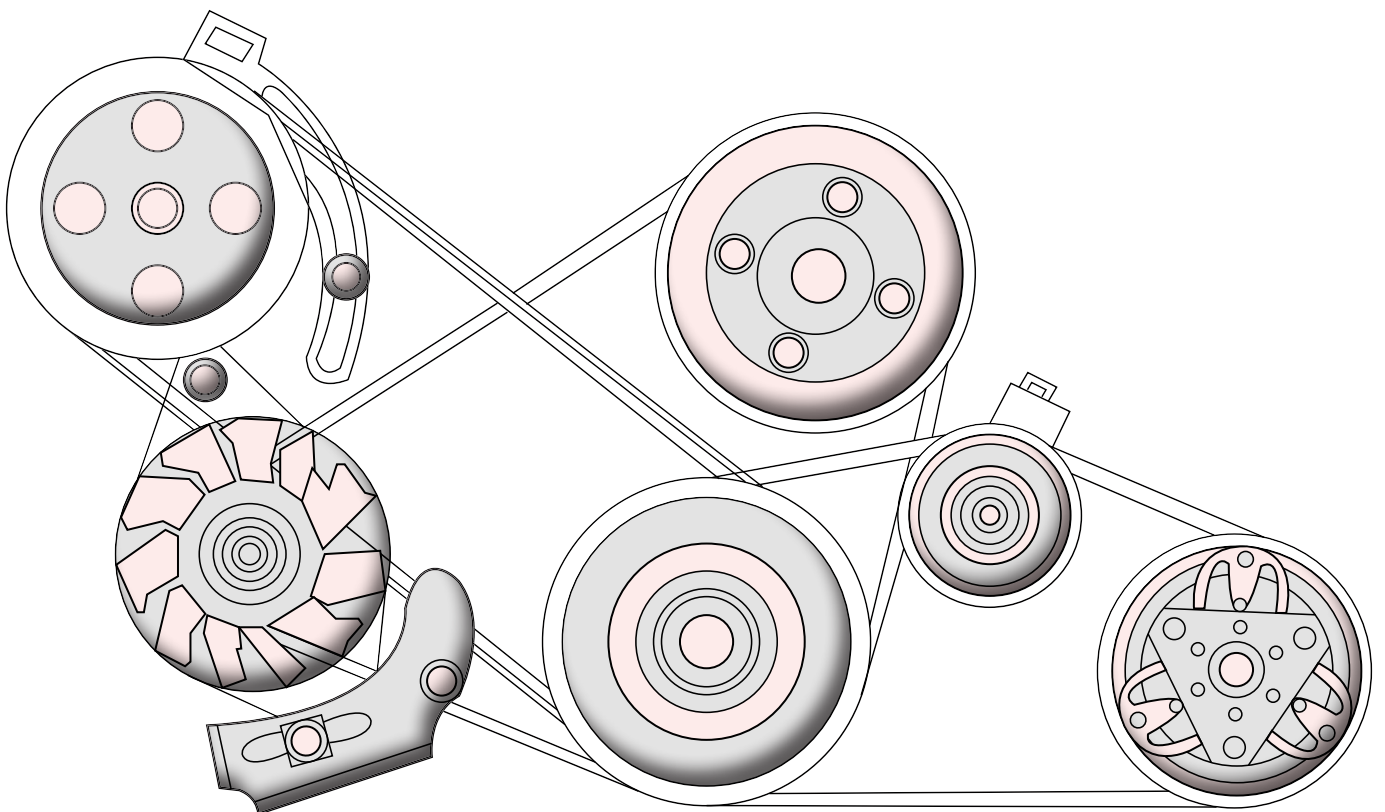

BELT CONSTRUCTION

Escon V-Belts are constructed from tough, long-lasting natural and synthetic rubber, reinforced with HMLS polyester cords. Specially designed rubber compounds give heat and oil resistance which ensures that the belts will perform uniformly in a range of ambient temperatures.

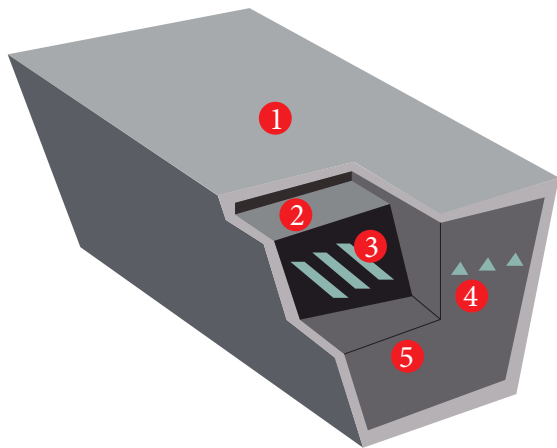

FEATURES

- Cover fabrics enhance durability by protecting inner parts.
- Specially designed cords enhance durability and length stability.
- Excellent oil and heat resistance.
- Enhances power transmission efficiency by reducing slip.

CONSTRUCTION	FUNCTIONS	MATERIALS
1. Cover Fabric	Protects the inner parts of the belts and provides excellent abrasion	Polyester Cotton fabric and CR rubber.
2. Compression rubber	Maintain belt shape (upper) and cord line	Natural Rubber, Synthetic Rubber.
3. Tension member	Primary material for transferring power	High Strength HMLS Polyester Cords.
4. Cushion rubber	Supports and protects Tension member adhesion	Natural Rubber, Synthetic Rubber.
5. Specially compounded Base rubber	Maintains belt shape	Natural Rubber, Synthetic Rubber.

ESCON CLASSICAL V-BELT

Escon V-belts remain the most widely used and offer reliable service with minimum maintenance in majority of medium and heavy duty industrial applications .

- a) Cover : Escon V-Belt Bias cut cover fabric is impregnated with special Chloroprene rubber to provide excellent oil, heat and abrasion resistance.
- b) Tension Member : Super Strength Polyester Cords ensure length stability and trouble free performance .
- c) Top Compression Section : High heat dissipating rubber compound can withstands increased flexing and sudden shock loads.
- d) Insulation Section: This holds the tension members in place and acts as a binding force between cords, top and bottom Compression Sections.
- e) Bottom Compression Set : The bottom compound is specially compounded to resist compression fatigue and heat for longer service life.

Wrapped type belts manufactured by Escon are A, B, C, D and E sections.

Escon V-Belts confirm to IS 2494 standards.



ESCON WEDGE BELT

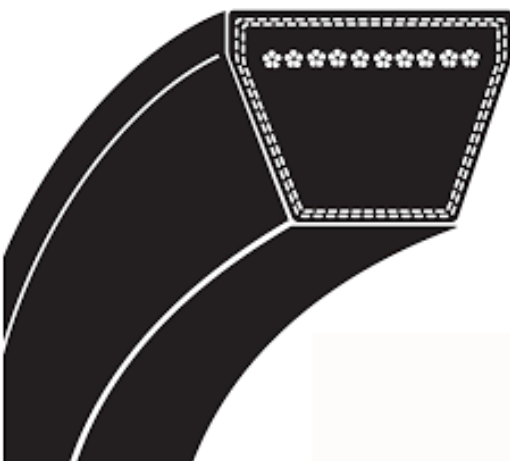

Escon Heavy duty Wedge belts contain high modulus polyester cords , which together with specially formulated bottom compression rubber compound and insulation rubber , constitute over unshakable union even under severest flexing conditions .

Escon Wedge belts do not buckle even on the toughest segments and are most preferred in most compact industrial drives.

Escon Wedge belts confirm to IS 14261 and BS 3790

Wedge belts manufactured by ESCON are SPZ, SPA, SPB, SPC, 3V, 5V and 8V

ESCON HEXAGONAL BELT

Escon Hexagonal Belts are used on the drives with one or more reverse bends and usually transmit power on both sides of the belt .

Escon Hexagonal Belts possess extra flexibility which allows hassle free bending on both the sides and can with stand to extra stresses encountered in agricultural applications.

These belts are available in standard AA, BB and CC sections. They are commonly used on agricultural machinery.

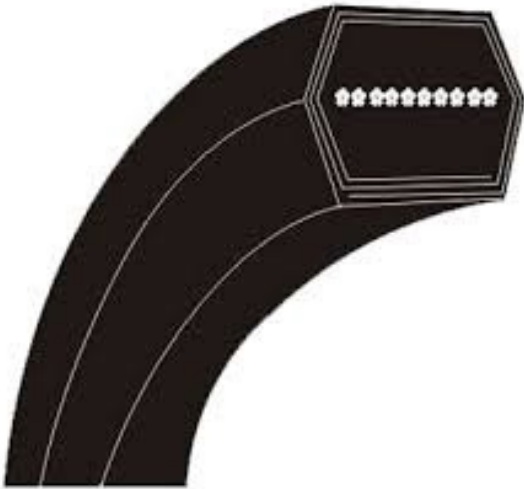

ESCON BANDED BELT

ESCON Banded V-Belts are two or more V-belts joined together with a high quality Polychloroprene compounding fabric into a single driving belt unit and joined together by a common backing.

These belts are especially useful in heavy-duty applications in which these belts ensure equal load distribution in drives where high shock or vibration problem occur which can cause the belt to flip over or jump out of the Pulley grooves.

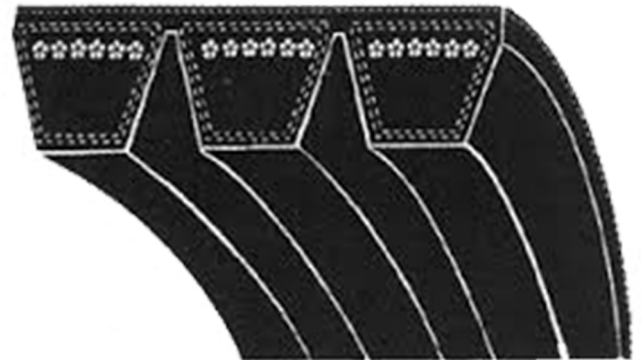

ESCON HARVESTOR COMBINE BELT

ESCON HARVESTOR COMBINE V-belts are used in agricultural machinery work in extreme conditions, especially outdoors, where they are exposed to sun, dust, dirt, stones and other objects which can get between the belt and the pulley. In addition, Harvester belts often work in very operationally challenging transmission systems that are subjected to frequent overloads. During the design of new agricultural machinery, manufacturers take into consideration these conditions and trust Escon Harvester Combine Belts which have been created by a team of engineers with experience in V-Belt Compounding and construction for several decades. These belts are found most suitable design and they adapt to these conditions properly.

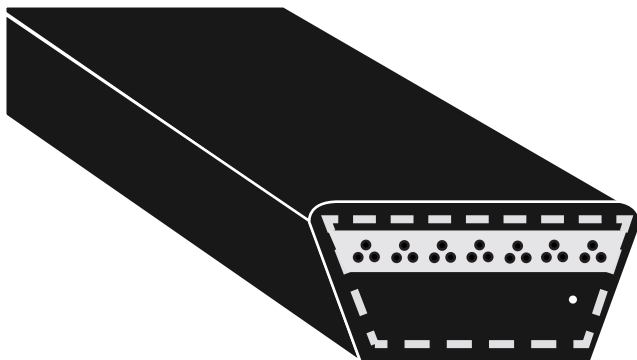

ESCON FLAT TRANSMISSION BELT

ESCON FLAT BELTS ARE MANUFACTURED WITH SYMMETRICALLY SET COTTON WOVEN HARD DUCK FABRICS WHICH ARE INFUSED WITH SPECIAL RUBBER COMPOUND.

THE TRANSMISSION BELT IS PRE STRETCHED AND POSSES THE REQUIRED ELASTICITY .

The Edges of the transmission belt are treated and special quoting is done to prevent ingress of moisture and prevent edge wear.

ESCON DELUXE (31 OZ) AND ESCON SUPER DELUXE (34 OZ) transmission belts are made from HARD DUCK SPECIAL COTTON fabrics conforming to BIS 1370: 1993 (Specification) .



ESCON FHP BELT



ESCON Fractional Horse Power (FHP) V-belts are used for light-duty industrial machinery and domestic appliances.

ESCON FHP Belt possess excellent flexibility, Smooth and quiet operation in fractional horsepower drive applications.

ESCON RAW EDGE COGGED BELT

These belts due of their design & construction can be used on Smaller Pulley dia than the recommended for conventional V Belts. These Belts provide better grip with Pulley surface and transmit maximum percentage of power in comparison to conventional V Belts. As a result they save power while running, the Teeth type construction at the base leads to better heat dissipation and the belts run cooler. For long service life the construction features wear, oil and heat resistance top and bottom fabric.

They are manufactured in sections AX, BX ,CX, 3VX, 5VX SPZX(XPZ), SPAX(XPA), SPBX(XPB) and SPCX(XPC).

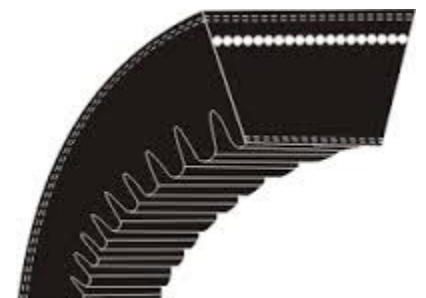

ESCON POLY BELT

Escon Ribbed belts have a fibre-reinforced backing and a large Power Transmitting surface area which gives them high tractability and keeps the belt secure in the pulley. They generate little noise in running and ensure the reliable functioning of all auxiliary devices. Escon Poly belt provide high flexibility and great power performance as they combine the benefits of flat and V Belts.

APPLICATIONS

Suited for Passenger Cars, Multi utility vehicles (MUV) and Commercial vehicles.

BENEFITS

- Single belt for multiple drives
- Highly flexible
- Good resistance to heat, wear and tear
- Low noise and vibration when in use
- Optimum drive stability
- Strong shock load tolerance
- Excellent tensile properties
- Oil, Heat , Ozone resistant



ESCON MUD LOADER BELT

ESCON MUD LOADER BELT ARE SPECIALLY DESIGNED TO GIVES VERY HIGH LIFE DUE TO ITS GREAT TENSILE AND EXCELLENT BONDING.



ESCON FR & FRAS V- BELTS

We manufacture V-belts with Fire resistant (FR) and Fire resistant in addition to antistatic (FRAS) properties for working environments such as coal mines and sensitive petro chemical installations. Our belts comply with the requirements of BS 3790 and ISO 1813 standards. Manufactured in all classical and wedge section V-belt as given in the dimension table.

ARAMED CORD REINFORCED V- BELT

Escon Manufactures all classical and wedge section V-Belts with aramid cord reinforcement.

Special Features :

Very high tensile strength & Modulus.

Very less elongation.

High power rating capacity.

Higher flex fatigue resistance.

Higher shock load absorption capacity.

Higher thermal stability.

Manufactured in all classical and wedge section V-belt as given in the dimension table.

ESCON PROFILE TOP CONICAL V- BELT

Profile Top V-Belts are available in the classical B and C sections and are mainly used for conveying purposes in the Ceramic Tiles Industry.

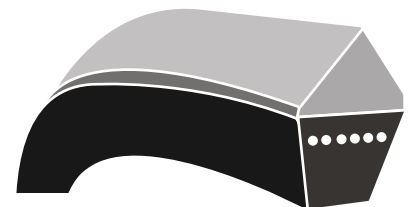

ESCON DIMENSIONS TABLES

ESCON CLASSICAL V- BELT

Belt Section	Nominal Top Width (m.m)	Nominal Thickness (m.m)	Nominal Angle (°)	Our Manufacturing Range Inside Length (Inches)	Reference Standard
Z	10.0	6.0	40	14" - 56"	IS 2494 and BS. 3790
A	13.0	8.0	40	18" - 160"	
B	17.0	11.0	40	18" - 300"	
C	22.0	14.0	40	36" - 620"	
D	32.0	19.0	40	95" - 620"	
E	38.0	23.0	40	160" - 620"	

ESCON WEDGE SECTION

Belt Section	Nominal Top Width (m.m)	Nominal Thickness (m.m)	Nominal Angle (°)	Our Manufacturing Range Inside Length (Inches)	Reference Standard
SPZ	9.7	8.0	40	1600 - 3350	IS 14261 and BS. 3790
SPA	12.7	10.0	40	1600 - 3500	
SPB	16.3	13.0	40	1500 - 7500	
SPC	22.0	18.0	40	1850 - 15800	

ESCON WEDGE SECTION

Belt Section	Nominal Top Width (m.m)	Nominal Thickness (m.m)	Nominal Angle (°)	Our Manufacturing Range Inside Length (Inches)	Reference Standard
3V	9.7	8.0	40	640 - 1320	RMA - IP - 22
5V	15.8	13.0	40	600 - 3030	
8V	25.0	23.0	40	780 - 8000	

FRACTIONAL HORSE POWER BELTS

Belt Section	Nominal Top Width (m.m)	Nominal Thickness (m.m)	Nominal Angle (°)	Our Manufacturing Range
FHP	10.0	6.0	40	2170 - 2540

HARVESTER COMBINE BELTS

Belt Section	Nominal Top Width (m.m)	Nominal Thickness (m.m)	Nominal Angle (°)	Our Manufacturing Range effective length (m.m)	Reference Standard
HK	38.0	18.0	30	1800 - 2500	ISO - 3410
HM	51.0	22.0	30	2000 - 3300	

POWER CORD FLAT BELTS

Belt Section	Nominal Top Width (m.m)	Nominal Thickness (m.m)	Our Manufacturing Range inside length in (m.m)	Reference Standard
Flat Belt	75 to 150	6.0	2800 - 5700	JIS

WRAPPED V - BELT : HEXAGONAL BELT

Belt Section	Nominal Top Width (m.m)	Nominal Thickness (m.m)	Nominal Angle (°)	Our Manufacturing Range effective length (m.m)	Reference Standard
AA	13.0	10.0	40	69" - 140"	IS : 11038
BB	17.0	13.0	40	69" - 140"	

RAW EDGE COGGED V - BELT

Belt Section	Nominal Top Width (m.m)	Nominal Thickness (m.m)	Nominal Angle (°)	Our Manufacturing Range effective length (m.m)	Reference Standard
AVX10 AVX13 XPZ	10.0 13.0 9.7	8.0 10.0 8.0	38 38 38	630 - 4500 650 - 4500 620 - 4500	BS-3790 & DIN-7753
Belt Section	Nominal Top Width (m.m)	Nominal Thickness (m.m)	Nominal Angle (°)	Our Manufacturing Range Pitch length (m.m)	Reference Standard
XPA XPB XPC	12.7 16.3 22.0	10.0 13.0 18.0	38 38 38	650 - 4500 1800 - 4500 1850 - 4500	BS-3790 & DIN-7753
Belt Section	Nominal Top Width (m.m)	Nominal Thickness (m.m)	Nominal Angle (°)	Our Manufacturing Range inside length inches	Reference Standard
AX BX CX	13.0 17.0 22.0	8.0 11.0 14.0	38 38 38	23" - 175" 23" - 175" 68" - 175"	BS-3790 & DIN-7753

BANDED V - BELT

Section	Our Manufacturing Range Inside Length (Inches)	No. of Belts per band	Standard followed
HA	79" - 179"	2 - 12	BS 3790
HB	79" - 179"	2 - 12	BS 3790
HC	79" - 179"	2 - 10	BS 3790
HSPB	2050 m.m - 4550 m.m	2 - 12	BS 3790
HSPC	2100 m.m - 4600 m.m	2 - 10	BS 3790
H5V	790" - 1790"	2 - 12	RMA IP 22

POLY BELT

Belt Section	Nominal Thickness (m.m)	Rib Pitch (m.m)	Rib Angle (°)	Effective Length (m.m)	Reference Standard
2PK - 32PK	4.50	3.56	40	500 mm TO 4000 mm	RMA IP - 26

TROUBLE SHOOTING

SYMPTOMS	PROBABLE CAUSE	CORRECTIVE ACTION
Premature Belt Failure		
Broken Belts(s) Belts fail to carry load Edge cord failure	Under- designed drive Belt rolled or pried onto sheave Pulley misalignment Damaged tensile member	Redesign drive Use drive take-up when installing Check alignment & correct if required Follow correct installation procedure
Abnormal Belt Wear		
Wear on top surface Wear on Belt sidewalls Wear on bottom surface Undercord cracking/Hardening Belt surface hard	Rubbing against guard Belt-to-sheave fit incorrect Belt slip Misalignment Worn sheaves Belt bottoming on sheave groove Debris on sheaves sheave diameter too small Belt slipping Underdesign drive Hot drive environment	Replace or repair guard Use correct belt to sheave match Retension until slipping stops Realign sheaves Replace sheaves Use correct belt/sheave match Clean sheaves Use larger diameter sheaves Retension redesign Improper ventilation to drive
Belts Turnover or Come Off Drive		
Involves single or multiple belts	Misaligned sheaves Damaged tensile member Poor drive design/ Vibration Foreign material in grooves Mismatched belt set	Realign the sheaves Use correct installation Check design & vibration dampening Shield grooves and drive Replace with new set of matched belts
Belt Stretches Beyond Available Take-up		
Multiple belts stretch unequally Single belt or where all belts stretch evenly	Misaligned drive Mismatched belt set insufficient take-up allowance Grossly over/under designed drive	Realign and Retension drive install matched belt set Check take-up allowance Redesign drive
Belt Noise & Unusual Vibration		
Belt squeals or chirps Slapping sound Belts flapping Unusual or excessive vibration	Belts slip Loose belts Misaligned drive Loose belts (under tension belts) Mismatched belts Incorrect belt Pulley out of round	Retension Retension Realign pulleys Retension Install new matched set belts Use correct belt cross section in pulleys Replace with non-defective pulley
Hot Bearings		
Drive overtensioned Sheaves too small Poor bearing condition Sheaves too far out on shaft Belt slippage	Worn grooves, belt bottoming Poor drive design Bearing underdesigned Bearing not properly maintained Error and obstruction problems Drive undertensioned	Replace sheaves and retension Drive Redesign Check bearing design Align and lubricate bearing Place sheaves as close as possible Retension
Performance Problems		
Incorrect driven speed/Power transmission	Design error Belt slip	Use correct driver/driven sheave Retension drive

INSTALLATION AND MAINTENANCE

GENERAL GUIDELINES

1. Check the Pulley grooves, to be sure these are all equal in dimensions.
2. Check the Pulley for wear and remove any rust, dirt or grease causing the belt wear.
3. Check the bearings of Pulleys for periodic oiling.
4. Check the Pulley mounting and alignment. Incorrect Alignment may result in the short Belt life.
5. Never use Belt dressing.
6. Store the belt in clean, cool and dark places.
7. Keep proper ventilation for the drive.

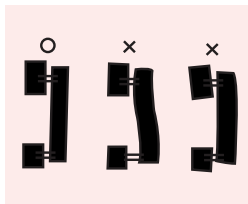
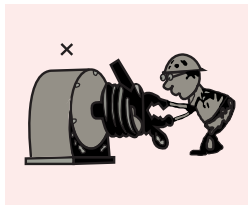
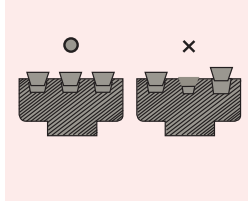

INSTALLATION

1. Never use new and used belts in a set, this may shorten the belt life due to unbalanced stretch of belts.
2. Slack off on take up until belts can be placed in grooves.
3. Tension the drive properly as described.
4. Do not use a lever to force the belts onto the pulleys.

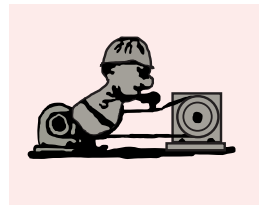
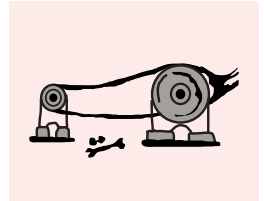

MATCHED SETS

Belts should be used in one Match set as per table below

Size Range		Number of Consecutive length codes, any of which may be used to make a matched sets.
Inch	mm	
70 - 100	1778 - 2540	2
101 - 210	2565 - 5334	3
211 & over	5359 & over	4

INSTALLATION AND OPERATION OF V- BELT DRIVES

INSTALLATION

In assembling a drive, the motor or prime mover should be moved towards the driven unit and the belt should be placed in the grooves by hand. Under no circumstances should V- Belt be forced on to pulley with screw drives or such implements.

TENSIONING

Measure the force required to cause a belt deflection of 1/64" per Inch. (16 mm per metre) of centre distance at the centre of span. Tension the drive so as to match the force with values in the table below. New drives should be tensioned to near the higher value. After the drive has been running for a few days, the drive tension should be rechecked.

Deflection 16 mm per metre of centre distance

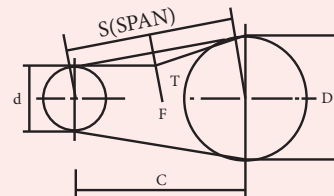

Belt Section	Belt Deflection Force (kgf)
A / SPZ	1.0 - 1.5 / 1.0 - 2.0
B / SPA	2.0 - 3.1 / 2.0 - 3.5
C / SPB	4.1 - 6.1 / 3.5 - 6.6
D / SPC	7.1 - 10.7 / 6.1 - 12.2
E	12.2 - 18.3

DRIVE DESIGN FORMULA

$$L = 2C + 1.57(D + d) + \frac{(D - d)^2}{4C}$$

$$C = A + \sqrt{A^2 - B}$$

Where

$$A = \frac{L}{4} - 0.3925(D + d)$$

$$B = \frac{(D - d)^2}{8}$$

$$\text{Number of belts } N = \frac{P \times F_s}{R \times F_1 \times F_c}$$

Where

L= Belt Pitch Length, mm

C= Centre Distance, mm

D= Pitch dia. of Large Pulley, mm

d= Pitch dia. of small pulley, mm

R= Power Rating per Belt, KW

F1= Belt length Correction Factor

Fc= Arc of contact correction Factor

Fs= Service Factor

P= Drive Power in KW

SELECTION OF V-BELT & WEDGE BELT CROSS SECTION

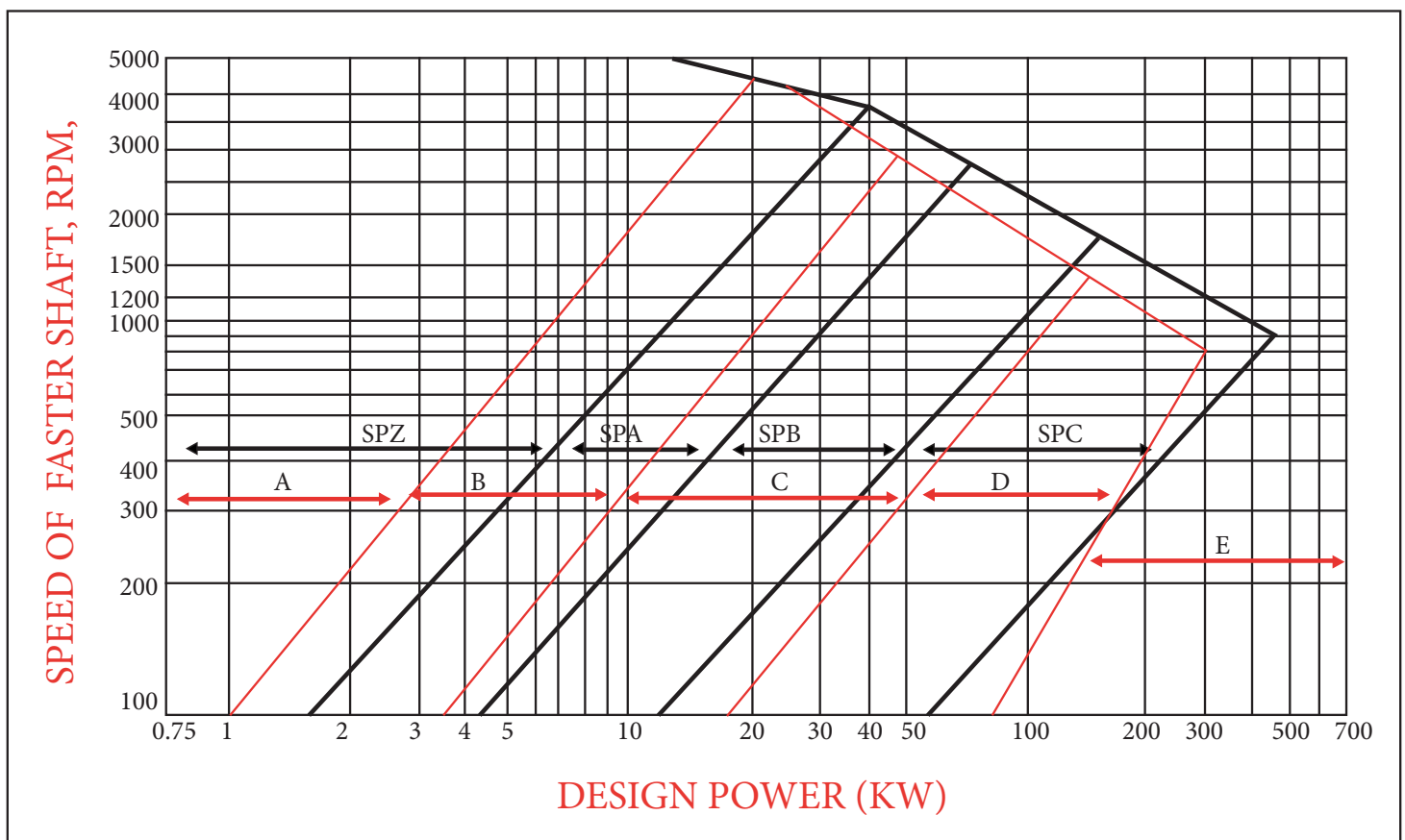

CORRECTION FACTOR FOR INDUSTRIAL SERVICE (F_s)

Severity Of Service	Type of Driven Machine For Speed Increasing Drives, Multiply F_s with : 1.00 for speed ratio 1.00 to 1.24 1.05 for speed ratio 1.25 to 1.75 1.11 for speed ratio 1.76 to 2.49 1.18 for speed ratio 2.50 to 3.49 1.25 for speed ratio 3.50 and over	Type of Driven Units					
		A.C. Motors, normal torque, squirrel cage, synchronous and split phase D.C. Motors, shunt wound, multiple cylinder internal combustion engine over 600 RPM			A.C. Motors, high torque, high slip repulsion - Induction, single phase, series wound and slip ring D.C. Motors, series wound and compound wound, single cylinder internal combustion engines, multiple cylinder internal combustion engines under 600 RPM, line shafts, clutches, brakes, direct on - line starting		
		Upto 10 h	Over 10 h to 16 h	Over 16 h & Continous Service	Upto 10 h	Over 10 h to 16 h	Over 16 h & Continous Service
LIGHT DUTY	Agitators for Liquids, blowers and exhausters, centrifugal pumps and compressors, fans upto 7.5 KW (10 HP) and light duty conveyors	1.0	1.1	1.2	1.1	1.2	1.3
MEDIUM DUTY	Belt conveyors for sand, grain etc., dough mixers, fan over 7.5 KW (10 HP), generators, line shaft, laundry machinery, machine tools, punches, presses and shears, printing machinery, positive displacement rotary pumps, revolving and vibrating screens	1.1	1.2	1.3	1.2	1.3	1.4
HEAVY DUTY	Brick machinery, bucket elevators, exciters, piston compressors, conveyors (drag - pan - screw), hammer hills, paper mill, beaters, piston pumps, positive displacement blowers, pulverizers, saw mill and wood - working machinery and textile machinery	1.2	1.3	1.4	1.4	1.5	1.6
EXTRA HEAVY DUTY	Crusher (gyratory - jaw - roll), mills (ball - rod - tube), hoists and rubber (calender - extruders - mills) machinery	1.3	1.4	1.5	1.5	1.6	1.8

CORRECTION FACTOR FOR ARC OF CONTACT (F_c)

$\frac{D-d}{c}$	Correction Factor F_c	Arc of contact on smaller pulley, degrees	$\frac{D-d}{c}$	Correction Factor F_c	Arc of contact on smaller pulley, degrees	$\frac{D-d}{c}$	Correction Factor F_c	Arc of contact on smaller pulley, degrees
0.00	1.00	180	0.50	0.93	151	1.00	0.82	120
0.05	0.99	177	0.55	0.92	148	1.05	0.81	117
0.10	0.99	174	0.60	0.91	145	1.10	0.80	113
0.15	0.98	171	0.65	0.90	142	1.15	0.78	110
0.20	0.97	169	0.70	0.89	139	1.20	0.77	106
0.25	0.97	166	0.75	0.88	136	1.25	0.75	103
0.30	0.96	163	0.80	0.87	133	1.30	0.73	99
0.35	0.95	160	0.85	0.86	130	1.35	0.72	95
0.40	0.94	157	0.90	0.85	127	1.40	0.70	91
0.45	0.93	154	0.95	0.83	123	1.45	0.68	87

Arc of contact below 120 degree should NOT be used unless complete Drive details are submitted to ESCON INTERNATIONAL PVT. LTD. for confirmation

POWER RATING OF V - BELTS AND WEDGE BELTS

V - BELT SECTION	SPEED OF FASTER PULLEYS (RPM)	POWER RATING (KW) PER BELT FOR SMALL PULLEY PITCH DIAMETER								
Smaller pulley Pitch Dia (mm)		80	85	90	95	100	106	112	118	125
A	720	0.60	0.68	0.75	0.83	0.90	0.99	1.08	1.16	1.26
	960	0.76	0.86	0.95	1.05	1.14	1.26	1.37	1.48	1.61
	1440	1.04	1.17	1.31	1.45	1.58	1.74	1.90	2.06	2.24
	2880	1.67	1.91	2.14	2.37	2.59	2.85	3.11	3.36	3.63
Smaller pulley Pitch Dia (mm)		125	132	140	150	160	170	180	190	200
B	720	1.61	1.79	1.99	2.24	2.48	2.73	2.97	3.21	3.45
	960	2.02	2.24	2.50	2.82	3.13	3.44	3.75	4.05	4.35
	1440	2.72	3.03	3.39	3.83	4.26	4.68	5.09	5.50	5.90
	2880	3.96	4.44	4.95	5.55	6.11	6.62	7.08	7.48	
Smaller pulley Pitch Dia (mm)		200	212	224	236	250	265	280	300	315
C	720	4.65	5.18	5.70	6.22	6.81	7.44	8.06	8.88	9.49
	960	5.76	6.42	7.08	7.72	8.46	9.24	10.00	10.99	11.72
	1440	7.49	8.36	9.21	10.03	10.95	11.91	12.82	13.96	14.76
Smaller pulley Pitch Dia (mm)		355	375	400	425	450	475	500	530	560
D	720	16.26	17.90	19.90	21.85	23.75	25.59	27.38	29.44	31.42
	960	19.26	21.16	23.45	25.63	27.70	29.65	31.47	33.50	35.32
	1440	21.22	23.03							
Smaller pulley Pitch Dia (mm)		500	530	560	600	630	650	710	750	800
E	585	26.60	28.20	32.10	35.60	37.70	40.10	43.70	47.40	50.80
	720	30.80	32.00	35.30	39.00	41.10	44.20	47.20	50.10	
	960	31.10	33.50	36.50						
WEDGE BELT SECTION	SPEED OF FASTER PULLEYS (RPM)	POWER RATING (KW) PER BELT FOR SMALL PULLEY PITCH DIAMETER								
Smaller pulley Pitch Dia (mm)		67	71	75	80	85	90	95	100	112
SPZ	720	0.61	0.70	0.79	0.90	1.01	1.12	1.23	1.34	1.60
	960	0.77	0.88	1.00	1.15	1.29	1.44	1.58	1.72	2.06
	1440	1.05	1.22	1.39	1.60	1.81	2.01	2.22	2.42	2.91
	2880	1.73	2.04	2.35	2.73	3.11	3.49	3.86	4.22	5.08
Smaller pulley Pitch Dia (mm)		100	106	112	118	125	132	140	150	160
SPA	720	1.53	1.76	1.99	2.22	2.48	2.75	3.05	3.42	3.79
	960	1.92	2.22	2.51	2.81	3.15	3.50	3.88	4.36	4.84
	1440	2.61	3.04	3.46	3.89	4.38	4.87	5.42	6.10	6.78
	2880	4.12	4.88	5.64	6.37	7.22	8.05	8.97	10.10	11.19
Smaller pulley Pitch Dia (mm)		160	170	180	190	200	212	224	236	250
SPB	720	4.54	5.11	5.68	6.25	6.81	7.49	8.15	8.82	9.58
	960	5.73	6.47	7.21	7.94	8.66	9.52	10.38	11.23	12.20
	1440	7.85	8.89	9.93	10.95	11.95	13.15	14.32	15.48	16.8
	2880	12.04	13.68	15.25	16.76					
Smaller pulley Pitch Dia (mm)		224	236	250	265	280	300	315	335	355
SPC	720	10.22	11.54	13.06	14.68	16.28	18.40	19.97	22.05	24.10
	960	12.68	14.36	16.30	18.35	20.38	23.05	25.02	27.61	30.16
	1440	16.59	18.88	21.5	24.25	26.94	30.43	32.96	36.23	39.37

ADDITIONAL POWER (KW) PER BELT FOR SPEED RATIO										
		1.02 TO 1.04	1.05 TO 1.08	1.09 TO 1.12	1.13 TO 1.18	1.19 TO 1.24	1.25 TO 1.34	1.35 TO 1.51	1.52 TO 1.99	2.00 AND OVER
132	140									
1.36	1.48	0.01	0.02	0.03	0.05	0.06	0.07	0.08	0.09	0.09
1.74	1.88	0.01	0.03	0.04	0.06	0.08	0.09	0.10	0.12	0.12
2.42	2.62	0.02	0.04	0.06	0.10	0.12	0.14	0.16	0.17	0.17
3.90	4.19	0.04	0.08	0.12	0.18	0.23	0.27	0.31	0.35	0.35
		0.03	0.05	0.08	0.12	0.15	0.18	0.20	0.23	0.23
		0.03	0.07	0.10	0.16	0.20	0.24	0.27	0.30	0.30
		0.05	0.10	0.15	0.23	0.30	0.36	0.41	0.46	0.46
		0.10	0.20	0.30	0.46	0.61	0.71	0.81	0.91	0.91
355	400									
11.05	12.75	0.07	0.14	0.21	0.32	0.42	0.49	0.56	0.63	0.63
13.58	15.51	0.09	0.19	0.28	0.45	0.56	0.66	0.75	0.85	0.85
16.67		0.14	0.28	0.42	0.68	0.85	0.99	1.13	1.27	1.27
600										
33.91		0.25	0.50	0.75	1.25	1.50	1.75	2.00	2.25	2.25
		0.33	0.67	1.00	1.60	2.00	2.33	2.67	3.00	3.00
		0.50	1.00	1.50	2.50	3.00	3.50	4.00	4.50	4.50
900										
56.00		0.41	0.83	1.24	2.07	2.48	2.89	3.30	3.72	3.72
		0.50	0.99	1.49	2.48	2.98	3.51	3.98	4.48	4.48
		0.66	1.33	1.98	3.31	3.97	4.63	5.29	5.95	5.95
ADDITIONAL POWER (KW) PER BELT FOR SPEED RATIO										
		1.02 TO 1.05	1.06 TO 1.11	1.12 TO 1.18	1.19 TO 1.26	1.27 TO 1.38	1.39 TO 1.57	1.58 TO 1.94	1.95 TO 3.38	3.39 AND OVER
125	140									
1.88	2.20	0.01	0.03	0.05	0.06	0.08	0.09	0.10	0.11	0.12
2.42	2.84	0.01	0.04	0.06	0.08	0.10	0.12	0.13	0.15	0.15
3.43	4.02	0.02	0.05	0.09	0.13	0.15	0.18	0.20	0.22	0.23
5.97	6.97	0.04	0.11	0.18	0.25	0.30	0.36	0.40	0.44	0.46
180	200									
4.52	5.24	0.02	0.07	0.12	0.16	0.20	0.23	0.26	0.28	0.30
5.79	6.72	0.03	0.09	0.16	0.21	0.26	0.30	0.34	0.37	0.40
8.10	9.40	0.05	0.14	0.24	0.32	0.39	0.46	0.51	0.56	0.59
13.24		0.10	0.27	0.47	0.64	0.78	0.91	1.03	1.12	1.19
280	315									
11.21	13.06	0.05	0.14	0.25	0.33	0.41	0.48	0.54	0.59	0.62
14.26	16.60	0.07	0.19	0.32	0.44	0.54	0.62	0.70	0.77	0.81
19.55	22.57	0.10	0.28	0.48	0.66	0.79	0.94	1.06	1.15	1.21
		0.20	0.56	0.97	1.32	1.60	1.88	2.11	2.31	2.44
375	400									
26.13	28.63	0.16	0.43	0.76	1.03	1.25	1.46	1.65	1.80	1.90
32.66	35.71	0.21	0.58	1.01	1.37	1.67	1.95	2.20	2.40	2.54
42.38		0.31	0.87	1.51	2.06	2.50	2.93	3.30	3.60	3.81

CORRECTION FACTOR FOR BELT LENGTH (F1)

FACTOR	BELT LENGTH (MM)								
	SPZ	A	SPA	B	SPB	C	SPC	D	E
0.80	--	610	--	--	--	1295	--	--	--
0.81	--	660	--	889	--	--	--	--	--
0.82	--	711	800	--	--	1524	--	--	--
0.83	630	--	--	965	--	--	--	--	--
0.84	--	787	900	1016	--	--	--	--	--
0.85	710	813	--	1067	1250	1727	--	--	--
0.86	--	--	1000	--	--	--	2000	3048	--
0.87	800	889	--	1168	1400	1905	--	3251	--
0.88	--	965	1120	--	1500	--	2240	--	--
0.89	900	1016	--	1295	1600	2057	--	--	--
0.90	--	1067	1250	--	--	2159	2500	3658	--
0.91	--	--	--	1473	1800	2286	2800	--	--
0.92	1000	1168	1400	--	--	2438	--	4013	--
0.93	--	--	--	--	2000	--	3150	--	--
0.94	1140	1295	1600	1651	--	2667	--	4572	5334
0.95	--	--	--	1778	2240	2845	3550	--	--
0.96	1250	1397	1800	--	2500	--	--	5334	6045
0.97	--	--	--	1905	--	3048	4000	--	--
0.98	1400	1524	2000	--	2800	3251	4500	--	--
0.99	--	--	--	2159	--	--	--	--	6807
1.00	1600	1651	2240	2286	3150	3658	5000	6045	--
1.01	--	1778	--	--	--	--	--	--	7569
1.02	1800	1905	2500	2464	3550	4013	5600	--	--
1.03	--	--	--	2540	--	--	6300	6807	8331
1.04	2000	2032	2800	2667	4000	--	--	--	--
1.05	--	--	--	2845	--	4572	7100	--	9093
1.06	2240	2286	3150	--	4500	--	--	--	--
1.07	--	--	--	3048	--	--	8000	8331	9855
1.08	2500	2438	3550	3251	5000	5334	--	--	--
1.09	--	--	--	--	--	--	9000	9093	10617
1.10	2800	2667	4000	--	5600	--	10000	--	--
1.11	--	2845	--	3658	6300	--	--	9855	--
1.12	3150	--	4500	--	--	--	11200	10617	12141
1.13	--	3048	--	4013	7100	--	--	--	--
1.14	--	3251	--	4115	--	6807	12500	--	13665
1.15	3550	--	--	--	8000	--	--	--	--
1.16	--	--	--	4572	--	--	--	12141	--
1.17	--	--	--	--	--	--	--	--	15189
1.18	--	--	--	--	--	--	--	13665	--
1.19	--	--	--	5334	--	--	--	--	--
1.20	--	--	--	--	--	--	--	15189	--
1.21	--	--	--	--	--	9093	--	--	--
1.22	--	--	--	--	--	--	--	--	--
1.23	--	--	--	--	--	9855	--	--	--
1.24	--	--	--	--	--	10617	--	--	--

MANUFACTURING UNIT



OTHER PRODUCTS OF ESCON GROUP

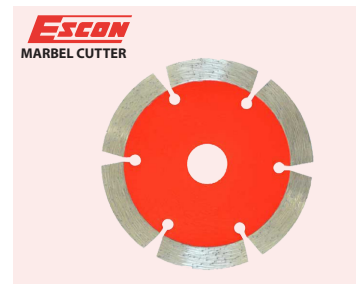

Corporate Office :

Escon House , 509 ,Kucha Pati Ram , Bazar Sita Ram , Delhi -110006 .
Tel: 011-23233257 , 011-23233259 , Email id: esconipl@gmail.com, esconipl@yahoo.com

Branches and Networks at :

Rajasthan , Haryana , Telangana , Tamil Nadu , Kerala , Himachal Pradesh, Uttar Pradesh and Bangalore